

NAS1000X12SXX SMT Non-Isolated Point-of-Load Converters 8.5V – 18V input, 0.75V -5.5V 12A output



DOSA Compatible
RoHS compliant parts available

Features

- High efficiency, 92% (12Vin, 3.3Vout@12A)
- Excellent thermal performance
- High output current: 12A
- Wide input-voltage range: 8.5V - 18V
- Wide output-voltage range: 0.75V to 5.5V
- Monotonic start-up into pre-biased load
- Output trim
- Remote sense
- Remote enable control
- Small footprint: 1.3''x0.53''x0.25''
- All components meet UL 94V0

Applications

- Intermediate bus architecture
- Telecom, datacom, networking equipment
- Electronic data processing, servers
- Distributed power architectures

Options

- Baseplate
- Negative/Positive enable logic
- Output over-voltage protection
- Output voltage tracking/Sequence

This *NAS* non-isolated point-of-load (POL) dc-dc converters deliver up to 12A of current in industry standard SMT packages with high efficiency and unparalleled thermal performance. The *NAS* converters provide competitive cost, high performance, high reliability and quality, and flexibility of use in a wide range of applications. The open frame design with integrated magnetics has a low profile (0.25''), achieving industry-leading power density and enhanced airflow for nearby components. As a benefit of the high efficiency and resulting superior thermal performance, these converters can provide high output currents in challenging environments with simple thermal management. These converters provide input under-voltage lockout, remote sense, wide output voltage trim, overload and short circuit protection and over-temperature shutdown as standard features. NetPower also offers optional output over-voltage protection which provides increased protection and system reliability in practical applications. The output voltage sequence/tracking features allows the output voltage to track an external signal during startup and shutdown in systems with sensitive powering timing requirements. To further improve thermal performance in extreme environments, NetPower offers a baseplate option for these POL converters. The baseplate option also allows the converters to be used in conduction-cooled systems.

NAS converters are excellent choices for today's densely packed systems with limited board space. The wide input and output voltage ranges and user-friendly features are ideal for telecom, datacom, wireless networks, computing, industrial, and automotive applications.

† UL is a registered trademark of Underwriters Laboratory Inc.

Absolute Maximum Ratings

Excessive stresses over these absolute maximum ratings can cause permanent damage to the converter. Also, exposure to absolute maximum ratings for extended periods of time can adversely affect the reliability of the converter. Operation should be limited to the conditions outlined under the Electrical Specification Section.

Parameter	Symbol	Min	Max	Unit
Input Voltage (continuous)	V_i	-0.5	22	Vdc
Operating Ambient Temperature (See Thermal Consideration section)	T_o	-40	85*	°C
Storage Temperature	T_{stg}	-55	125	°C

* For operation above 85°C ambient temperature, please consult NetPower for derating guidance.

Electrical Specifications

These specifications are valid over the converter's full range of input voltage, resistive load, and temperature unless noted otherwise.

Input Specifications

Parameter	Symbol	Min	Typ	Max	Unit
Input Voltage	V_i	8.5	12	18	Vdc
Input Current	$I_{i,max}$	-	-	10	A
Quiescent Input Current ($V_{in} = 12$, $V_o = 3.3V$)	$I_{i,Qsnt}$	-	70	100	mA
Standby Input Current	$I_{i,stdby}$	-	2		mA
Inrush Transient	I^2t	-	-	0.5	A ² s
Input Reflected-ripple Current, Peak-to-peak (5 Hz to 20 MHz, 1 μ H source impedance)	-	-	20	-	mAp-p
Input Ripple Rejection (120 Hz)	-	-	30	-	dB
Input Turn-on Voltage Threshold	-	-	8.3	-	V

Output Specifications

Parameter	Symbol	Min	Typ	Max	Unit
Output Voltage Set Point Tolerance ($V_i = 12$ V; $I_o = I_{o,max}$; $T_a = 25^\circ$ C)	-	-2.0	-	2.0	%
Output Voltage Set Point Tolerance (over all conditions)	-	-2.5	-	3.50	%
Output Regulation:					
Line Regulation ($V_i = 8.5V$ to 18V, $I_o = 1/2$ of load)	-	-	0.2		% V_o
Load Regulation ($I_o = I_{o,min}$ to $I_{o,max}$, $V_i = 12V$)	-	-	0.3		% V_o
Temperature ($T_a = -40^\circ$ C to 85 °C)	-	-	0.2		% V_o
Output Ripple and Noise Voltage (5 Hz to 20 MHz bandwidth, $V_{in} = 12V$)	Peak-to-peak -	-	1.5		% V_o
	RMS	-		1	% V_o
External Load Capacitance	-	-	-	5,000	μ F
Output Current	I_o	0	-	12	A
Output Current-limit Trip Point	$I_{o,cli}$	-	200	-	% I_o
Output Short-circuit Current, hiccup mode			2		A
Switching frequency	-	270	300	330	kHz
Output Over Voltage trip point (optional, hiccup mode)			6.25		V
Voltage Tracking/Sequencing Slew Rate – Power UP				2	V/ms
Voltage Tracking/Sequencing Slew Rate – Power down				1	V/ms

Output Specifications (continued)

Parameter	Symbol	Min	Typ	Max	Unit
Efficiency (Vi = 12V; Io = Iomax, TA = 25°C)	Vo = 0.8V	η	77		%
	Vo = 1V	η	80		%
	Vo = 1.2V	η	82.5		%
	Vo = 1.5V	η	85		%
	Vo = 1.8V	η	87		%
	Vo = 2.5V	η	90		%
	Vo = 3.3V	η	92		%
	Vo = 5V	η	93.5		%
Consult factory for Vo > 5.5V					
Dynamic Response (Vi = 12V; Ta = 25°C; Load transient 0.1A/μs)					
Load step from 50% to 75% of full load:					
Peak deviation			50		mV
Settling time (to 10% band of Vo deviation)			40		μs
Load step from 50% to 25% of full load					
Peak deviation			50		mV
Settling time (to 10% band of Vo deviation)			40		μs

General Specifications

Parameter	Symbol	Min	Typ	Max	Unit
Remote Enable					
Negative Logic:					
Logic Low – Module On	-	-	-	-	-
Logic High – Module Off					
Positive Logic:					
Logic High – Module On	-	-	-	-	-
Logic Low – Module Off					
Logic Low:					
ION/OFF = 1.0mA	VON/OFF	0	-	0.5	V
VON/OFF = 0.0V	ION/OFF	-	-	1.0	mA
Logic High:					
ION/OFF = 0.0μA	VON/OFF	-	-	15	V
Leakage Current	ION/OFF	-	-	20	μA
Over-temperature Protection	To	-	120	-	°C
Turn-on Time (Io = full load, Vo within 1% of setpoint)	-	-	6	-	ms
Calculated MTBF (Bellcore TR-332, 40°C, full load)			> 5		10 ⁶ -hour

Characteristic Curves

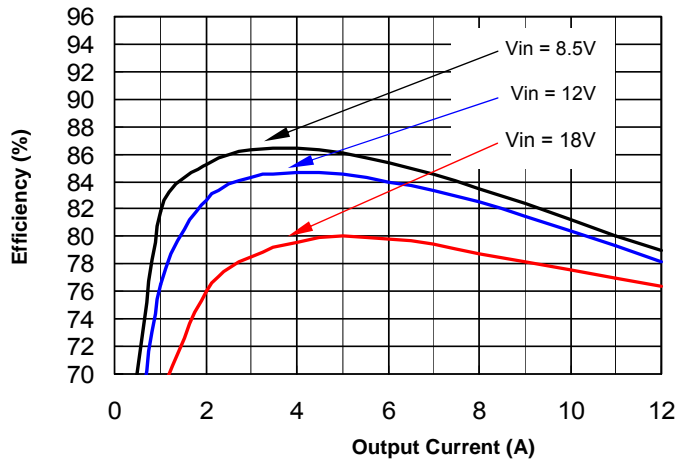

Figure 1(a). Efficiency vs. Load Current (25°C, 0.8V output)

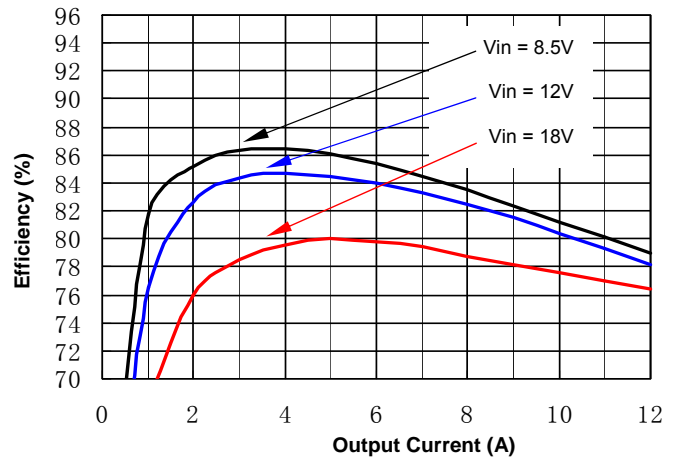

Figure 1(b). Efficiency vs. Load Current (25°C, 1.0V output)

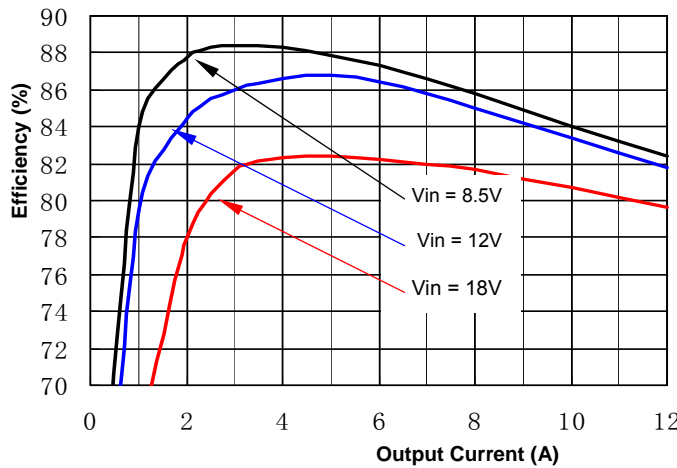

Figure 1(c). Efficiency vs. Load Current (25°C, 1.2V output)

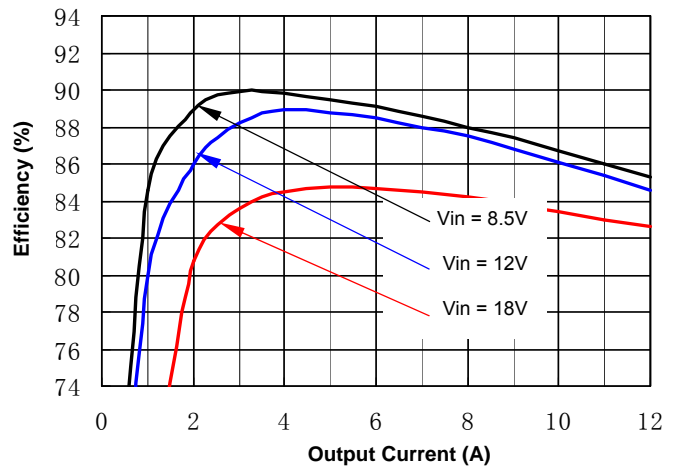

Figure 1(d). Efficiency vs. Load Current (25°C, 1.5V output)

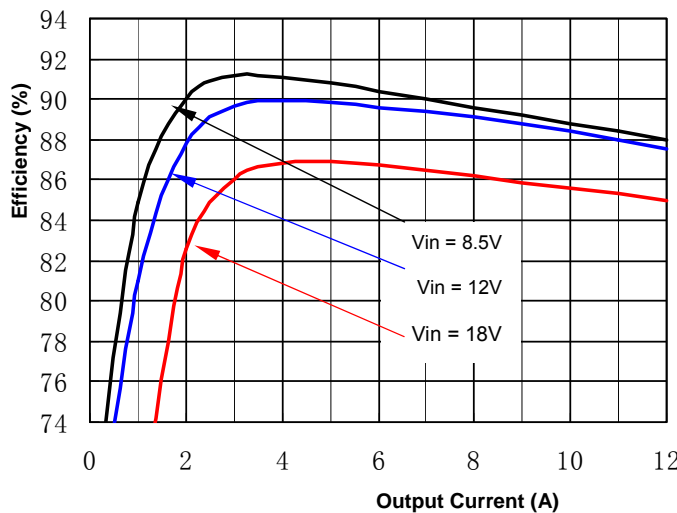

Figure 1(e). Efficiency vs. Load Current (25°C, 1.8V output)

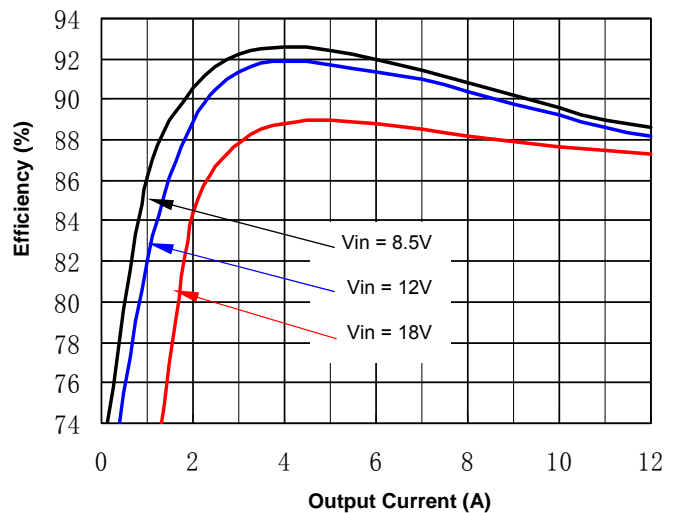

Figure 1(f). Efficiency vs. Load Current (25°C, 2.5V output)

Characteristic Curves

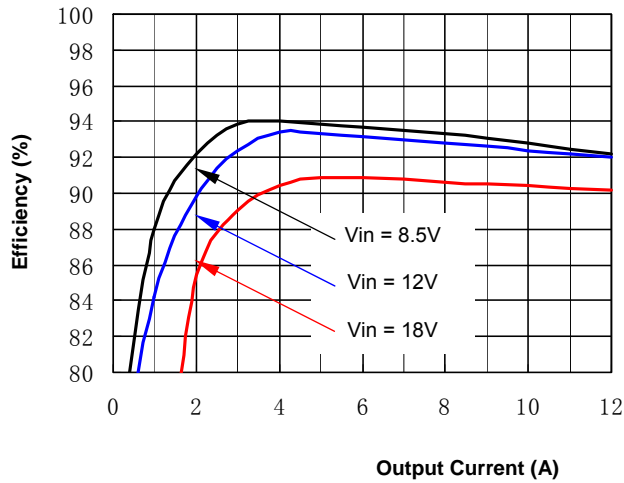

Figure 1(g). Efficiency vs. Load Current (25°C, 3.3V output)

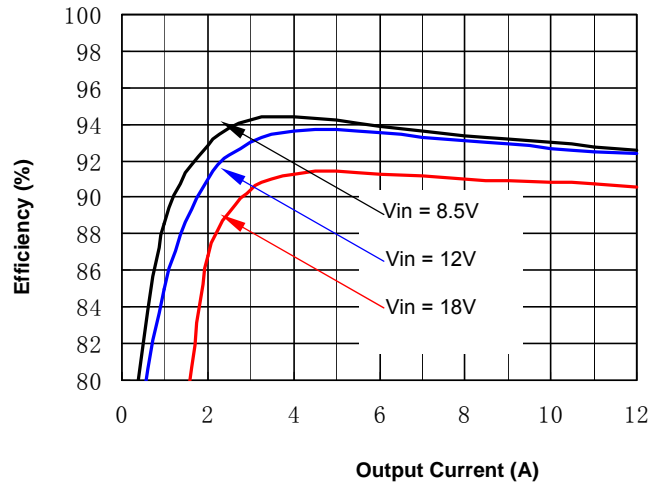

Figure 1(h). Efficiency vs. Load Current (25°C, 5V output)

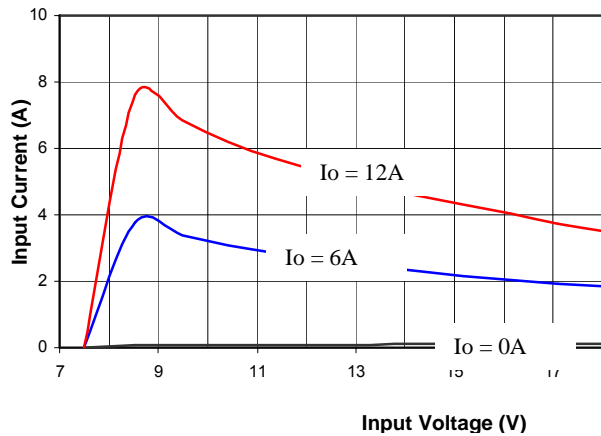

Figure 2. Input Characteristic (5V output)

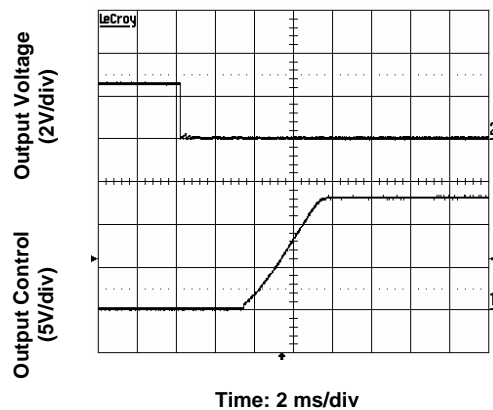

Figure 3. Start-Up from Enable Control Input voltage 12V, Output current 0A

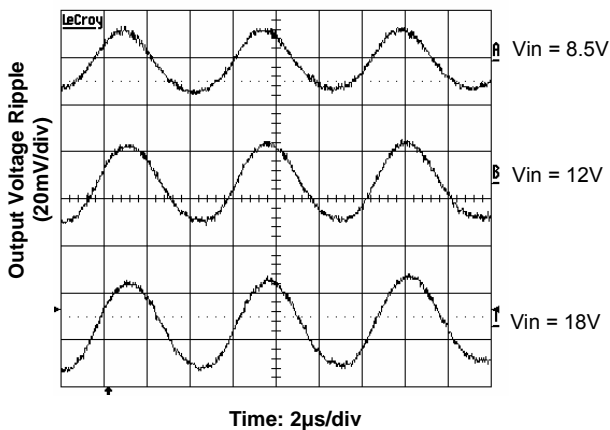

Figure 4. Output Ripple Voltage at 2.5V, 12A Output

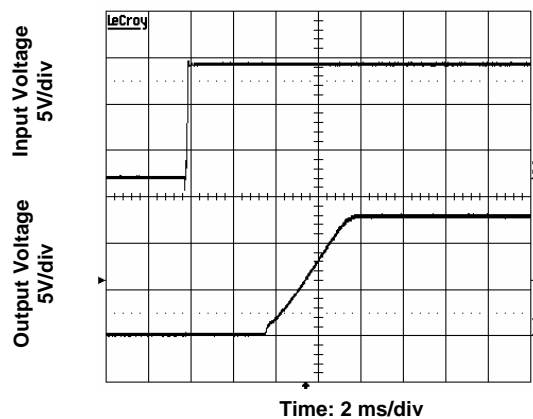

Figure 5. Start-Up from Application of Input Voltage Input voltage 12V, Output current 0A

Characteristic Curves

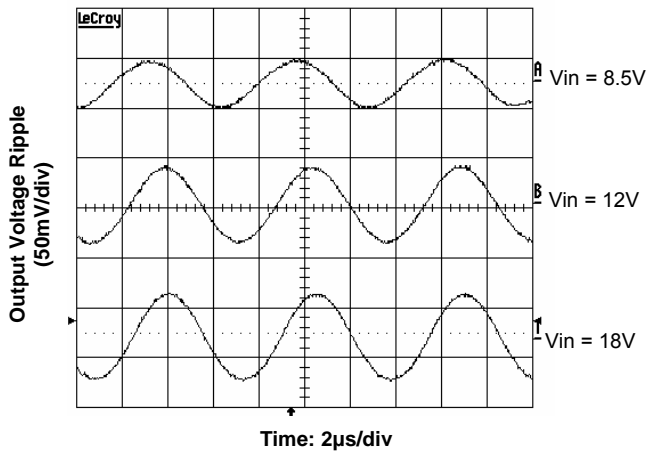

Figure 6. Output Ripple Voltage at 5V, 12A Output

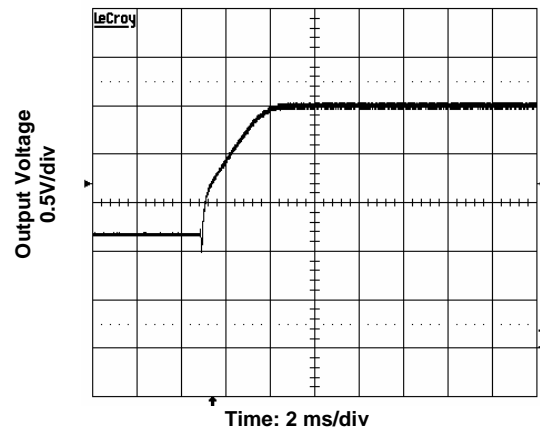

Figure 7. Start-Up with Prebias Input voltage 12V, Output current 0A, Output voltage 2.5V, Prebias 1.2V

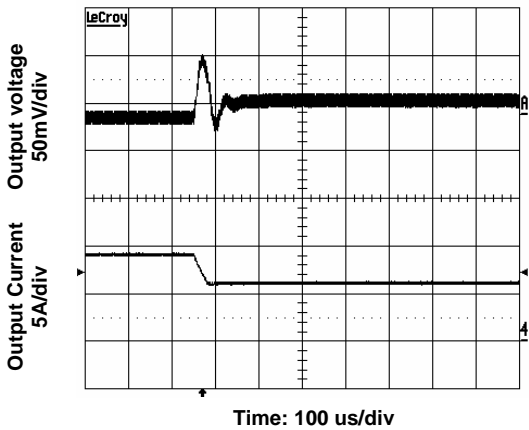

Figure 8. Transient Load Response. Output current 6A (50% full load), Input voltage 12V, Slew rate 0.1A/µs.

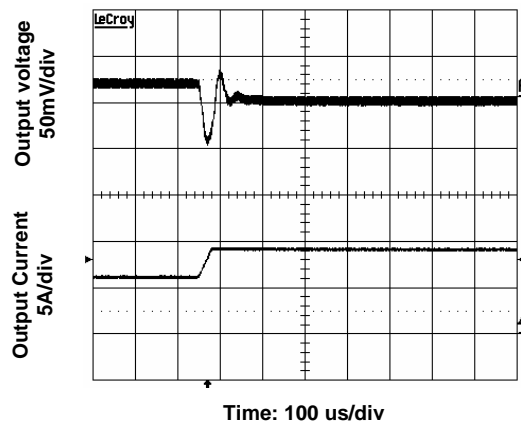

Figure 9. Transient Load Response. Output current 6A (50% full load), Input voltage 12V, Slew rate 0.1A/µs.

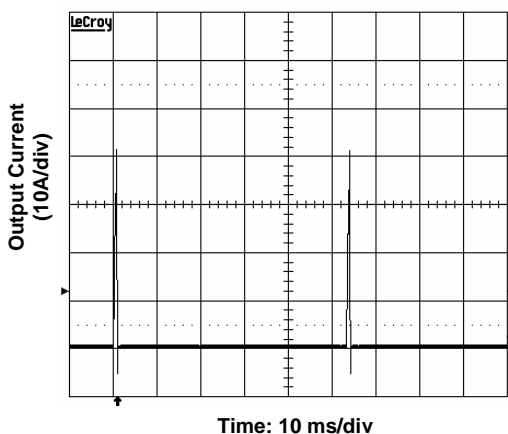

Figure 10. Short Circuit Current. $V_{in} = 12V$

Figure 11. TBD

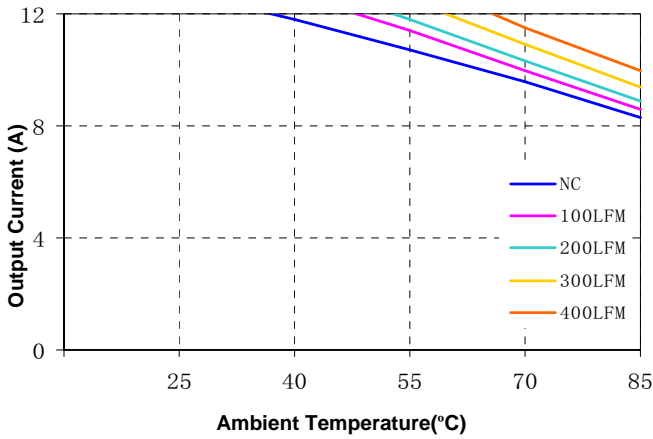

Figure 12(a). Current Derating Curve for 1V Output ($V_{in} = 12V$ open frame)

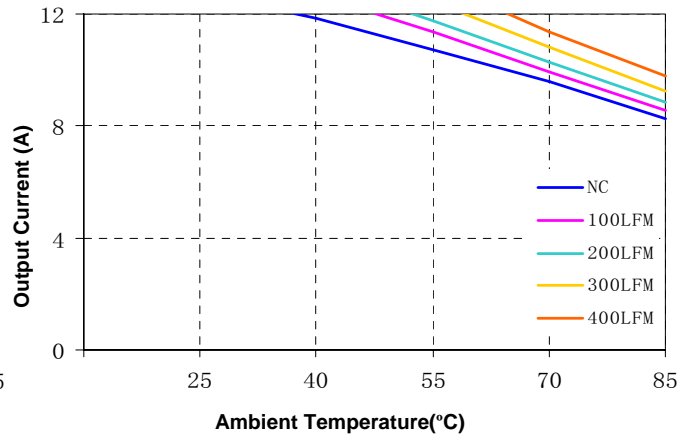

Figure 12(b). Current Derating Curve for 1.5V Output ($V_{in} = 12V$ open frame)

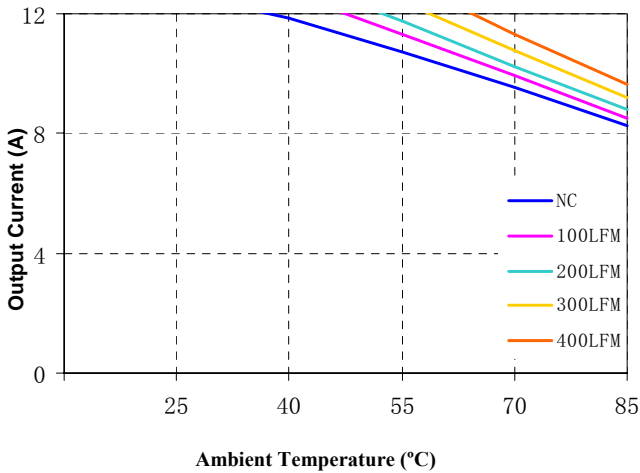

Figure 12(c). Current Derating Curve for 1.8V Output ($V_{in} = 12V$ open frame)

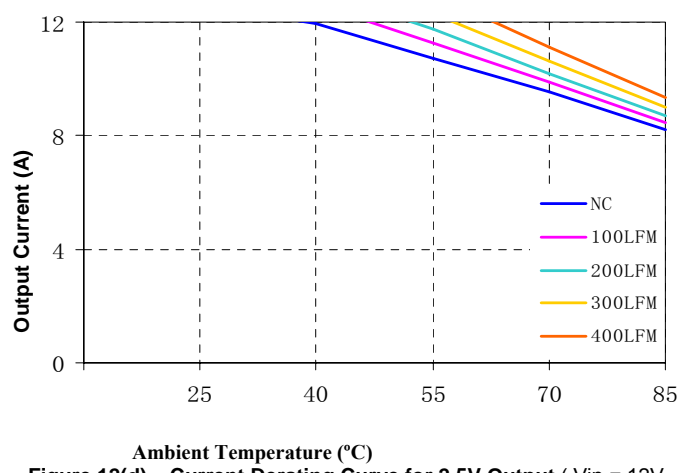

Figure 12(d). Current Derating Curve for 2.5V Output ($V_{in} = 12V$ open frame)

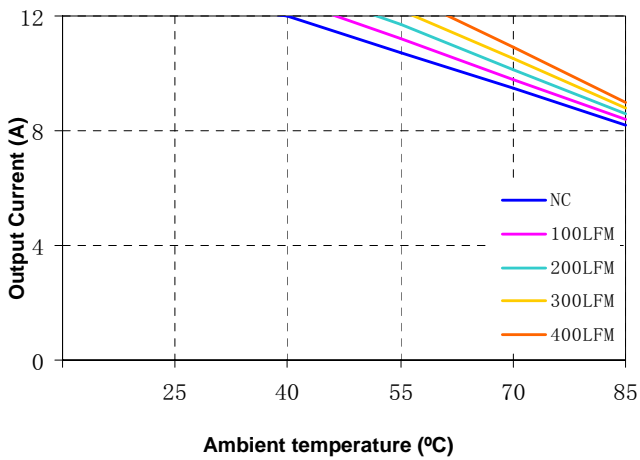

Figure 12(e). Current Derating Curve for 3.3V Output ($V_{in} = 12V$ open frame)

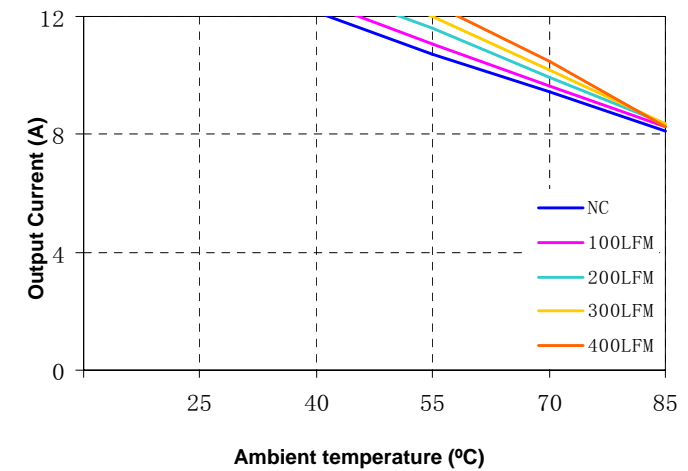

Figure 12(f). Current Derating Curve for 5.0V Output ($V_{in} = 12V$ open frame)

Feature Descriptions

Remote ON/OFF

The converter can be turned on and off by changing the voltage or resistance between the ON/OFF pin and GND. The NAS converters can be ordered with factory selectable positive logic or negative enabling logic.

For the negative control logic, the converter is ON when the ON/OFF pin is at a logic low level, and OFF when the ON/OFF pin is at a logic high level. With positive control logic, the converter is ON when the ON/OFF pin is at a logic high level and OFF when the ON/OFF pin is at a logic low level. The converter is ON no matter what control logic is when ON/OFF pin is left open (unconnected).

Figure 13 is the recommended ON/Off control circuit for positive logic modules, while Figure 14 is for negative logic modules. Recommended value of the pull up resistor $R_{pull-up}$ is 50K. The maximum allowable leakage current from this pin at logic-high level is 20 μ A.

The logic-low level is from 0V to 0.5V, and the maximum switch current during logic low is 2mA. The external switch must be capable of maintaining a logic-low level while sinking this current.

Remote SENSE

The remote SENSE pin is used to sense voltage at the load point to accurately regulate the load voltage and eliminate the impact of the voltage drop in the power distribution path.

The SENSE pin should be connected to the point where regulation is desired. The voltage difference between the output pins must not exceed the operating range of this converter shown in the specification table.

When remote sense is not used, the SENSE pin can be connected to the positive output terminals. If the SENSE pins are left floating, the converter will deliver an output voltage slightly higher than its specified typical output voltage. The OVP (output over-voltage protection) circuit senses the voltage across the output pins, so the total voltage rise should not exceed the minimum OVP setpoint given in the

Specifications Table in operation.

Because the converter does not have remote sense connection for GND, it is important to make sure that the connection resistance and voltage drop between GND pin and the load is small.

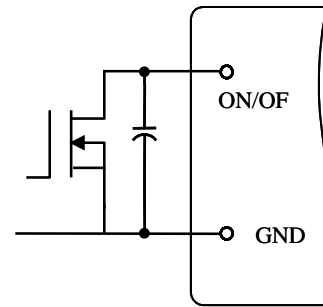

Figure 13 Circuit for Positive Logic Control

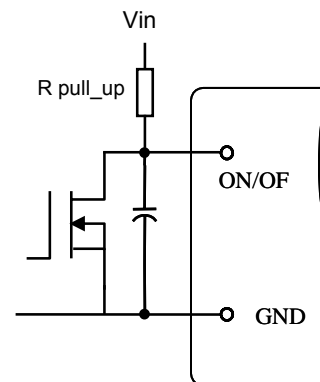

Figure 14 Circuit for Negative Logic Control

Output Voltage Programming and Adjustment

The output voltage of NAS1 converters are preset to 0.7525V, and can be trimmed up to 5.5V using an external trim resistor. With a trim resistor, the output voltage can only be adjusted higher than the present output voltage. To trim the voltage lower than the preset voltage, an external voltage has to be applied to the Trim pin.

The trim pin allows the user to adjust the output voltage set point with an external resistor or voltage. To increase the output voltage, a resistor should be connected between the TRIM pin and the GND pin. The output voltage can be adjusted down by changing the value of the external resistor using the equation below:

$$R_{trim} = \left(\frac{10.5}{\Delta} - 1 \right) (k\Omega)$$

Where $\Delta = V_o - 0.7525$

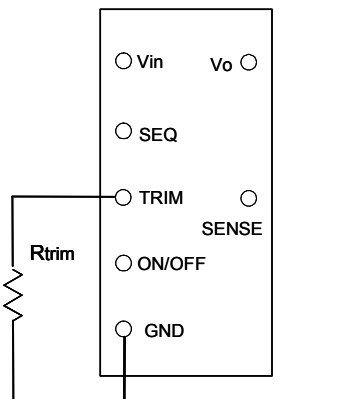

Fig. 15 Circuit to Trim Output Voltage

The circuit configuration for trim operation is shown in Fig. 15. Because NAS1 converters use GND as the reference for control, Rtrim should be placed as close to GND pin as possible, and the trace connecting GND pin and Rtrim should not carry significant current, to reduce the effect of voltage drop on the GND trace/plain on the output voltage accuracy.

When remote sense and trim functions are used simultaneously, please do not allow the output voltage at the converter output terminals to be outside the operating range.

Input Under-Voltage Lockout

This feature prevents the converter from turning on until the input voltage reaches 8.3V.

Output Over-Current Protection

As a standard feature, the converter turns off when the load current exceeds the current limit. If the over-current or short circuit condition persists, the converter will operate in a hiccup mode (repeatedly trying to restart) until the over-current condition is cleared.

Thermal Shutdown

As a standard feature, the converter will shut down if an over-temperature condition is detected. The converter has a temperature sensor located within the converter's circuit board, which detects the thermal condition of key components of the converter.

The thermal shutdown circuit is designed to turn the converter off when the temperature at the sensor reaches 120°C. The converter will resume operation after the converter cools down.

Output Over-Voltage Protection

As an optional feature, if the voltage across the output pins exceeds the output voltage protection threshold (6.25V) as shown in the Specifications Table, the converter will clamp the output voltage to protect the converter and the load. The converter automatically resumes normal operation after the over voltage condition is removed.

The typical over-voltage protection setpoint is 6.25V.

Voltage Tracking/Sequencing

An optional voltage tracking/sequencing feature is available with these converters. This feature is compatible with the "Voltage Sequencing" feature (DOSA) or the "Voltage Tracking" feature (POLA) seen in industry standards. If this feature is not used, the corresponding SEQ pin should be left open, or tied to a voltage higher than the output voltage but less than 15V.

This feature basically forces the output of the

spacing and construction (especially copper weight, holes and openings) of the fixture board and the spacing board, temperature measurement method, and the ambient temperature measurement point. The thermal derating curves in this datasheet are obtained by thermal tests in a windtunnel at 25°C, 55°C, 70°C, and 85°C. The converter's power pins are soldered to a 2-layer test fixture board through 18 AWG wires. The space between the test board and a PWB spacing board is 1". Usually, the end system board has more layer count, and has better thermal conduction than our test fixture board. For thermal considerations specific to your application environment, please contact NetPower's technical support team for assistance.

Heat Transfer without a Baseplate or Heatsink

Convection heat transfer is the primary cooling means for converters without a baseplate. Therefore, airflow speed is important for any intended operating environment. Increasing the airflow over the converter enhances the heat transfer via convection.

Figures 12 (a) through (f) show the current derating curves under nominal input voltage for a few output

voltages. To maintain long-term reliability, the module should be operated within these curves in steady state. Note: the natural convection condition can be measured from 0.05 - 0.15 m/s (10 - 30 LFM).

Heat Transfer with a Baseplate or Heatsink

The NAS1 converter can use a baseplate to further enhance their thermal performance. A baseplate works as a heat spreader, and thus can improve the heat transfer between the converter and its ambient.

An additional heatsink or cold-plate can be attached to the baseplate with external mechanical attachment. The heatsink/cold plate further improves the thermal performance of the converter.

NAS Converter Part Numbering System:

NAS	1	000	N	12	S	1	6	
Series Name:	Nominal Input Voltage:	Nominal Output Voltage:	Enabling Logic:	Rated Output Current:	Pin Length:	Electrical Option 1:	Mechanical Options	
							Lead-free, ROHS Compliant	Leaded (ROHS-5 Compliant)
NAS	1: 8.5 – 18V	000 = adj	P: Positive N: Negative	Unit: A 12 = 12A	S: SMT	0: None 1: output tracking 2: output OVP 3: tracking and OVP	5: None 6: Baseplate	0: None 1: Baseplate

*: fixed output models are available as semi-custom products.

The above example denotes a 12A output module in Pb-free (RoHS compliant) with negative enabling logic, voltage tracking, and baseplate options.

Mechanical Drawing dimensions in mm(inch)

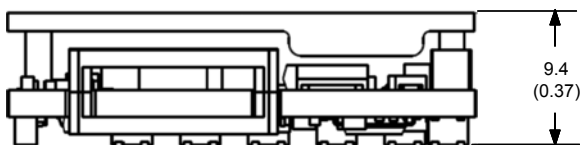
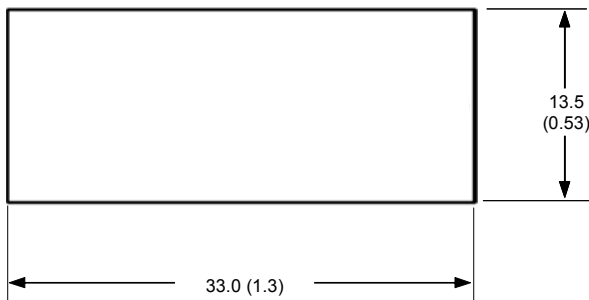
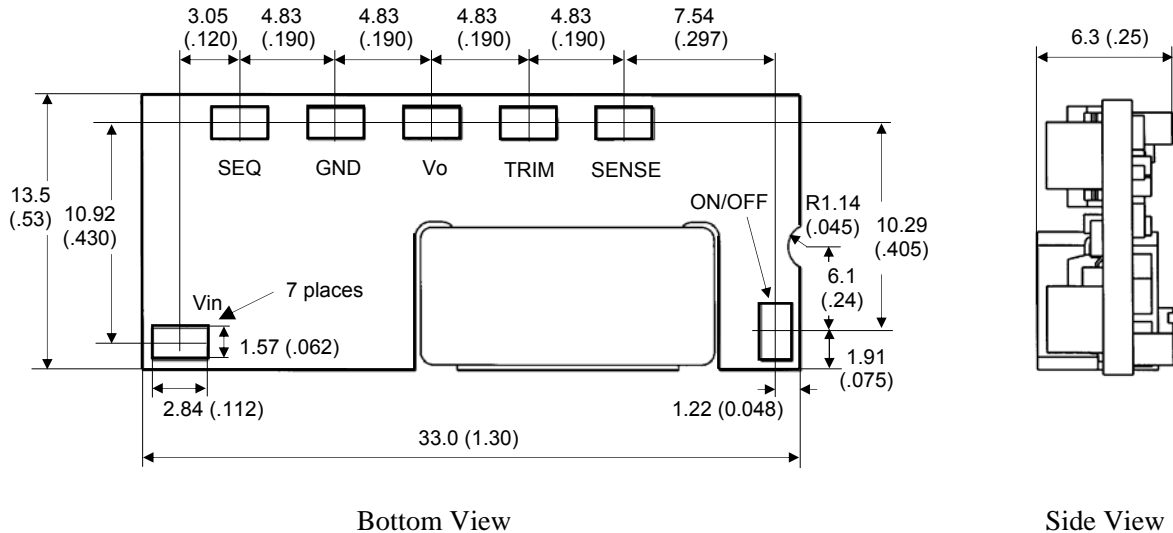

Converter with Baseplate

Notes

- 1) All dimensions in mm (inches). Tolerances:
 $x \pm .5$ ($.xx \pm 0.02$)
 $.xx \pm .25$ ($.xxx \pm 0.010$)
- 2) All pins are coated with gold or Matte Tin finish
- 3) Weight: 0.25oz(7g) open frame converter
- 4) Workmanship: Meet or exceed IPC-A-610 Class II
- 5) Baseplate flatness tolerance is 0.10mm (0.004") TIR for surface.

For more information, please contact:

 **NetPower** Technologies, Inc.
Toll Free: 866-NETPOWER (866-638-7693)
Local Phone: 972-560-0500
Fax: 972-560-0210
E-mail: sales@netpowercorp.com
www.netpowercorp.com
1680 Prospect Drive #200, Richardson, TX 75081

Warranty

NetPower offers a two (2) year limited warranty. Complete warranty information is listed on our web site or is available upon request. Information furnished by NetPower is believed to be accurate and reliable. However, no responsibility is assumed by NetPower for its use, nor for any infringements of patents or other rights of third parties which may result from its use. No license is granted by implication or otherwise under any patent or patent rights of NetPower.